

GRITTI

GRITTI

ARGO	Finitura Metallo / Metal Finishes		€
	B / N / NL	T / BR / OO	
	ARGO S1	•	
ARGO S1 LUX		•	353,00
ARGO S2	•		479,00
ARGO S2 LUX		•	521,00
ARGO S7	•		1.881,00
ARGO S7 LUX		•	2.083,00
ARGO P1	•		280,00
ARGO P1 LUX		•	313,00
ARGO P2	•		445,00
ARGO P2 LUX		•	485,00
ARGO TRK1	•		380,00
ARGO TRK1 LUX		•	443,00
ARGO TRK2	•		557,00
ARGO TRK2 LUX		•	597,00
ARGO TRK S1	•		380,00
ARGO TRK S1 LUX		•	443,00
ARGO TRK S2	•		557,00
ARGO TRK S2 LUX		•	597,00

Binario "One Truck by Stucchi" su richiesta / Mod. "One Truck by Stucchi" on demand.

	Finitura Vetro / Glass Finishes		€
	CR / DEN / VER / AMB / COR / AMT / ROS		
GLASS S40	•		80,00
GLASS L40	•		120,00
GLASS S70	•		100,00
GLASS L70	•		140,00

ARGO

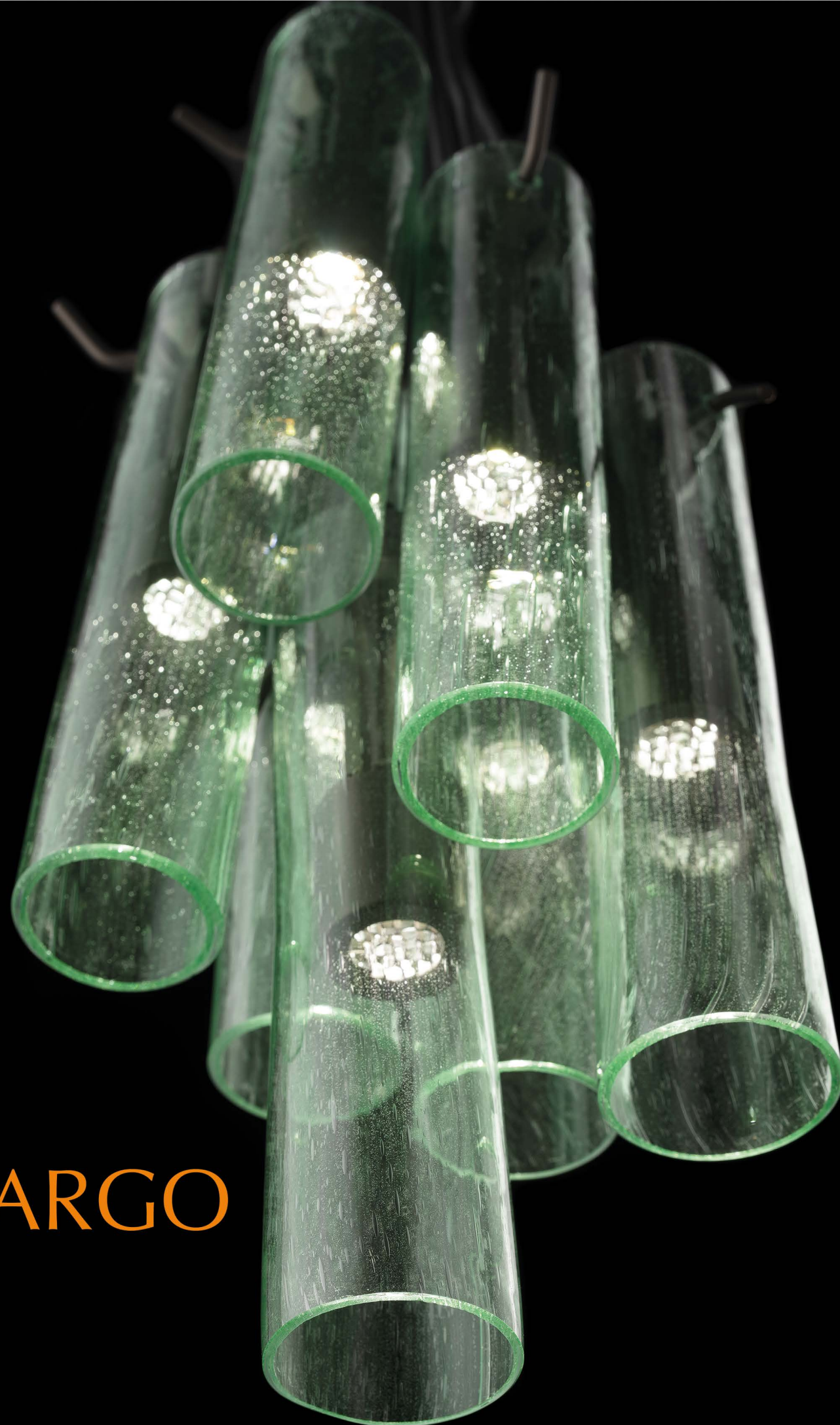

GRITTI

Collezione ARGO 40

DESIGNER

Marc Sadler

Sistema di apparecchi per l'illuminazione a spot con led di potenza. Montatura realizzata in alluminio laccato o naturale. Proiettore orientabile assemblato con ottiche per il controllo del fascio e schermo honeycomb antiabbagliamento. Diffusore decorativo in vetro soffiato pulegoso disponibile in vari colori. Sospensioni con cavo nero. Argo TRK 1 e Argo TRK S1 sono apparecchi compatibili con il sistema Onetrack Stucchi.

Luminaire system for spot lightning with power LED. Frame made of lacquered or natural aluminum. Adjustable projector assembled with optics for beam control and anti-glare honeycombs screen. Decorative diffuser in "Pulegoso" blown glass available in different colors. Suspensions with black wire. Argo TRK 1 and Argo TRK S1 are recessed luminaires compatible with the system "Onetrack Stucchi".

Nome articolo _ Item name	tipologia - type	alimentazione - supply	potenza - power	Kelvin	lumen	CRI
ARGO S1	sospensione suspension	220-240V 50/60Hz	3W	3000	430	≥ 90
ARGO S7	sospensione suspension	220-240V 50/60Hz	21W	3000	3010	≥ 90
ARGO P1	parete- plafone wall - ceiling	220-240V 50/60Hz	3W	3000	430	≥ 90
ARGO TRK1	parete per binario wall for track	24V	3W	3000	430	≥ 90
ARGO TRK S1	sospensione per binario suspension for track	24V	3W	3000	430	≥ 90

OTTICHE OPZIONALI : ANGOLI DI EMISSIONE -OPTIONAL OPTIC BEAM ANGOL

NB : NARROW BEAM 15°	MB : MEDIUM BEAM 30°	WB : WIDE BEAM 45°
----------------------	----------------------	--------------------

finiture montatura - frames finish

OO Oro Opaco Gold matt	T Titanio Titanium	NO Nero Opaco Black matt	B Bianco Withe	BR Bronzo Bronze	NL Naturale Natural
------------------------	--------------------	--------------------------	----------------	------------------	---------------------

DIFFUSORI IN VETRO PULEGOSO

"PULEGOSO" BLOWN GLASS DIFFUSER

	CR cristallo	DEN denim	VER verde	AMB ambra	COR corallo	AMT ametista	ROS rosso
S 40	•	•	•	•	•	•	•
L 40	•	•	•	•	•	•	•

CURVE FOTOMETRICHE SU RICHIESTA

PHOTOMETRIC CURVE ON DEMAND

S 40 IL VETRO CORTO the short glass	ARGO P1
L 40 IL VETRO LUNGO the long glass	

	ARGO S1	ARGO S7
	+ S 40	+ L 40

modular system for onetrack by Stucchi

ARGO TRK 1	ARGO TRK S1

Sistema di apparecchi per l'illuminazione a spot con led di potenza. Montatura realizzata in alluminio laccato o naturale. Proiettore orientabile assemblato con ottiche per il controllo del fascio e schermo honeycomb antiabbagliamento. Diffusore decorativo in vetro soffiato pulegoso disponibile in vari colori. Sospensioni con cavo nero. Argo TRK 1 e Argo TRK S1 sono apparecchi compatibili con il sistema Onetruck Stucchi.

*Luminaire system for spot lightning with power LED. Frame made of lacquered or natural aluminum. Adjustable projector assembled with optics for beam control and anti-glare honeycombs screen. Decorative diffuser in "Pulegoso" blown glass available in different colors. Suspensions with black wire.*

*Argo TRK 2 and Argo TRK S2 are recessed luminaires compatible with the system "Onetruck Stucchi".*

Nome articolo _ Item name	tipologia - type	alimentazione - supply	potenza - power	Kelvin	lumen	CRI
ARGO S2	sospensione suspension	220-240V 50/60Hz	6.2W	3000	700	≥ 90
ARGO P2	parete- plafone wall - ceiling	220-240V 50/60Hz	6.2W	3000	700	≥ 90
ARGO TRK2	parete per binario wall for track	24V	6.2W	3000	700	≥ 90
ARGO TRKS2	sospensione per binario suspension for track	24V	6.2W	3000	700	≥ 90

OTTICHE OPZIONALI : ANGOLI DI EMISSIONE -OPTIONAL OPTIC BEAM ANGOL

NB : NARROW BEAM 24°	MB : MEDIUM BEAM 35°	WB : WIDE BEAM 60°
----------------------	----------------------	--------------------

finiture montatura - frames finish

OO Oro Opaco Gold matt	T Titanio Titanium	NO Nero Opaco Black matt	B Bianco Withe	BR Bronzo Bronze	NL Naturale Natural
------------------------	--------------------	--------------------------	----------------	------------------	---------------------

DIFFUSORI IN VETRO PULEGOSO

"PULEGOSO" BLOWN GLASS DIFFUSER

	CR cristallo	DEN denim	VER verde	AMB ambra	COR corallo	AMT ametista	ROS rosso
S 70	•	•	•	•	•	•	•
L 70	•	•	•	•	•	•	•

CURVE FOTOMETRICHE SU RICHIESTA

PHOTOMETRIC CURVE ON DEMAND

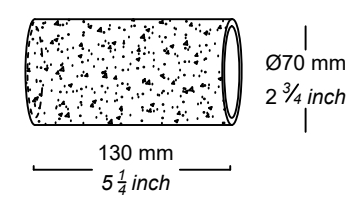
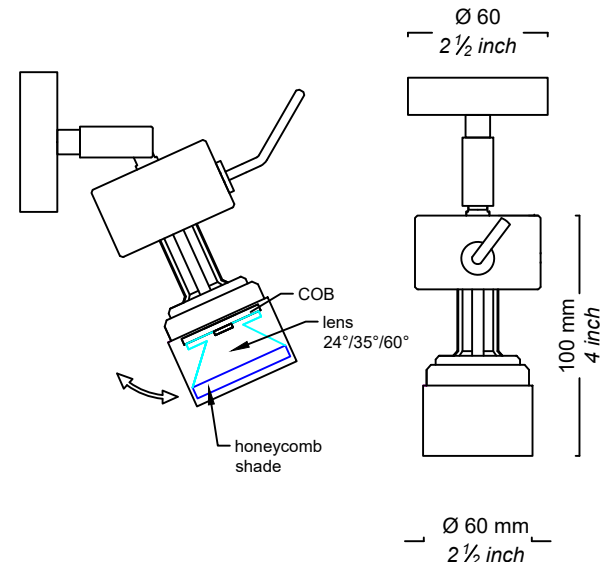
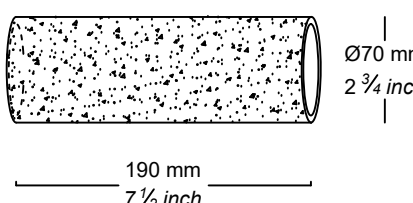
<p>S 70 IL VETRO CORTO the short glass</p> 	<p>ARGO P2</p> 
<p>L 70 IL VETRO LUNGO the long glass</p> 	

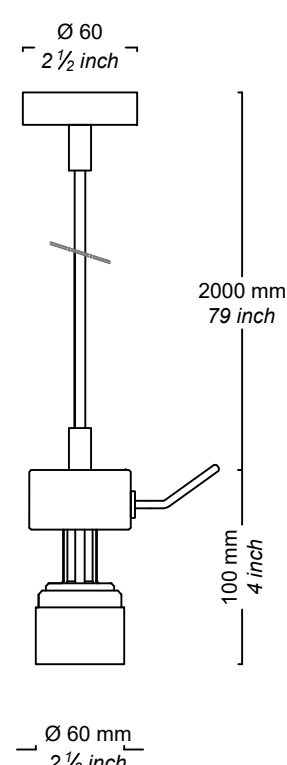
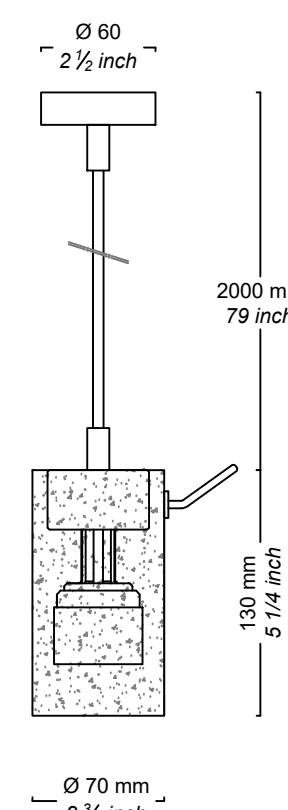
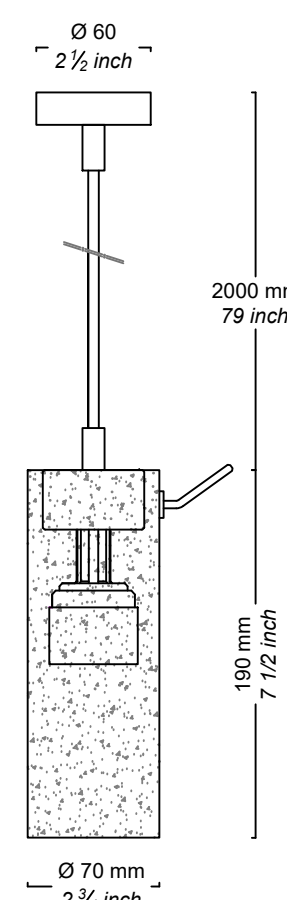
ARGO S2		
	+ S 70	+ L 70
		

moduli per sistema onetrack by Stucchi

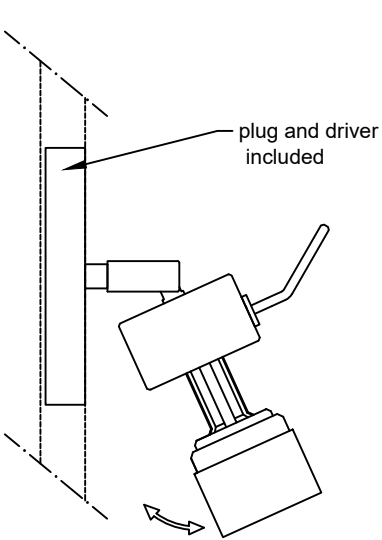
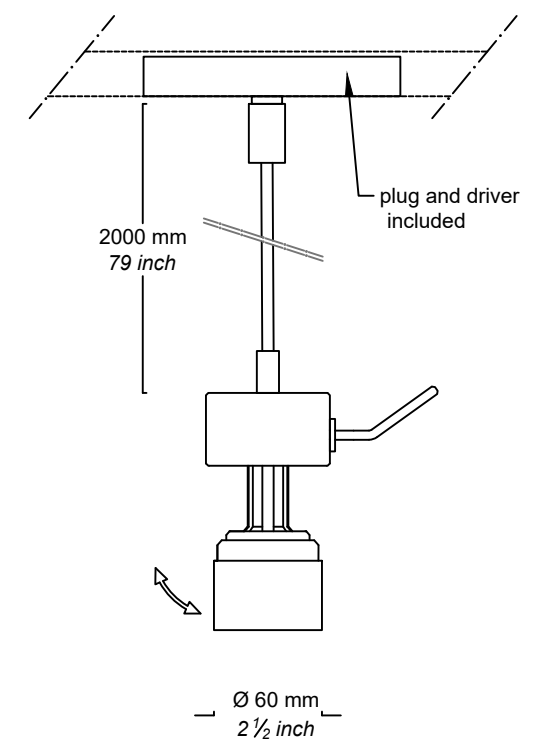
ARGO TRK 2	ARGO TRK S2
	



CRITTI

ATHENA	Finitura Metallo / Metal Finishes	Finitura Vetro / Glass Finishes		€
	B/N/T/BR/OO	AMB.R/CR.R	AMB.H/CR.H	
ATHENA 30	•	•		2.692,00
ATHENA 30 LUX	•		•	2.897,00
ATHENA 40	•	•		2.760,00
ATHENA 40 LUX	•		•	2.965,00
ATHENA 60	•	•		4.240,00
ATHENA 60 LUX	•		•	4.872,00
ATHENA 60 PLUS	•	•		5.917,00
ATHENA 60 PLUS LUX	•		•	6.728,00

---

R: Vetro Rigato / Ripped Glass

---

H: Vetro a Nido D'Ape / Hive Glass

---

ATHENA

GRITTI

Collezione ATHENA

DESIGNER

Marc Sadler

Apparecchi di illuminazione con montatura in metallo laccato. Schermi diffusori in vetro colato realizzato a mano con fracco rigadin o inserti il rete metallica con effetto nido d'ape. Le sospensioni centrali portano luce diretta con led di potenza.





Possibilità di doppia accensione su richiesta.

*Luminaires with frame in lacquered metal. Hand made cast glass diffuser with rigadin texture or metal mesh inserts with hive texture. The central suspensions project direct light with power LEDs.*

*Possibility of double lighting on request.*



Nome articolo _ Item name	Athena 30	Athena 40	Athena 60	Athena 60 plus
tipologia - type	sospensione - suspension	sospensione - suspension	sospensione - suspension	sospensione - suspension
alimentazione - supply	220-240V 50/60Hz	220-240V 50/60Hz	220-240V 50/60Hz	220-240V 50/60Hz
potenza - power	27 W	27 W	27 W	33 W
Kelvin	3000	3000	3000	3000
lumen	2120	2120	2120	2180
CRI	90	90	90	90

finiture montatura - frames finish

OO Oro Opaco Gold matt		T Titanio Titanium		NO Nero Opaco Black matt		B Bianco White		BR Bronzo Bronze	
---------------------------	---	-----------------------	---	-----------------------------	---	-------------------	---	---------------------	---

COLORI DEL DIFFUSORE IN VETRO COLATO

CAST GLASS DIFFUSER COLORS

AMB ambra amber		CRI cristallo clear	
--------------------	---	------------------------	---

CURVE FOTOMETRICHE SU RICHIESTA

PHOTOMETRIC CURVE ON DEMAND

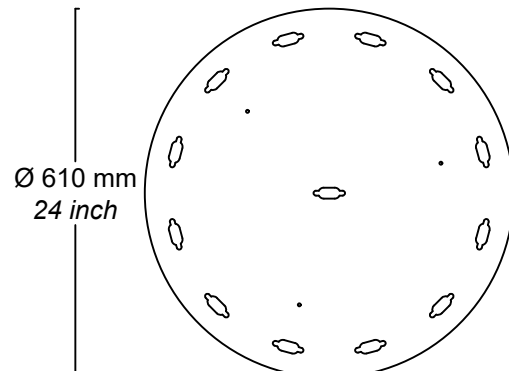
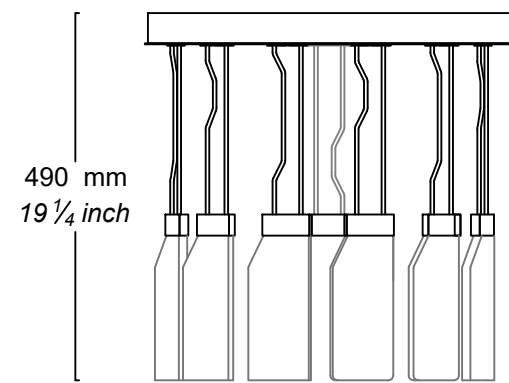
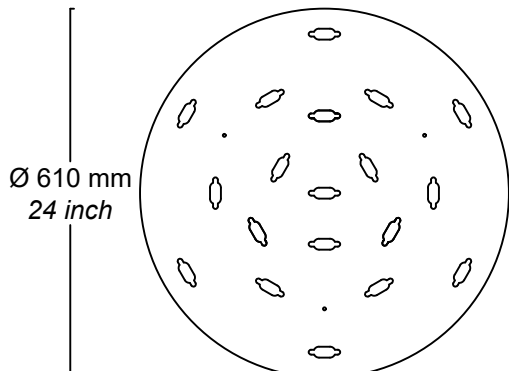
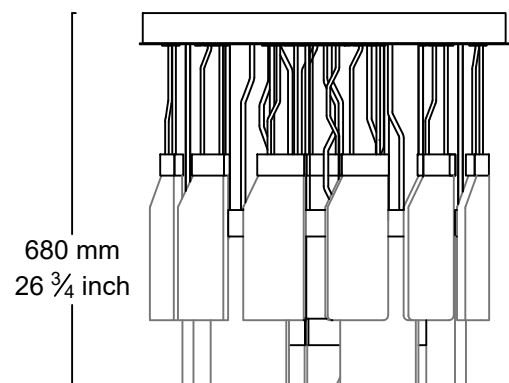
ATHENA 60	ATHENA 60 plus
 <p>Ø 610 mm 24 inch</p>  <p>490 mm 19 1/4 inch</p>	 <p>Ø 610 mm 24 inch</p>  <p>680 mm 26 3/4 inch</p>

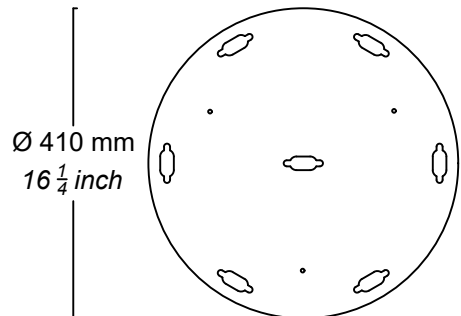
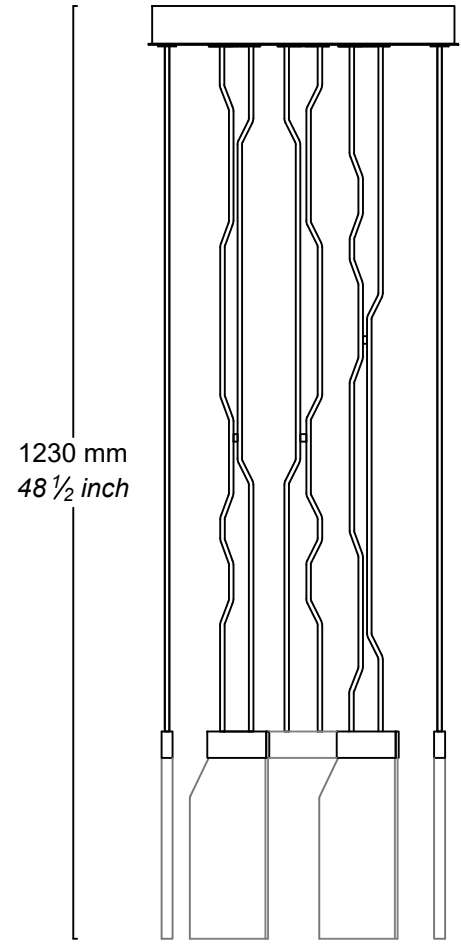
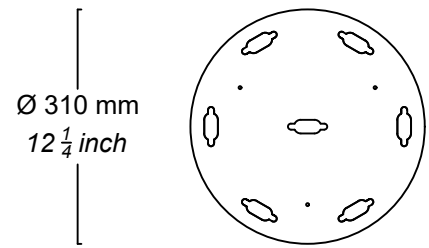
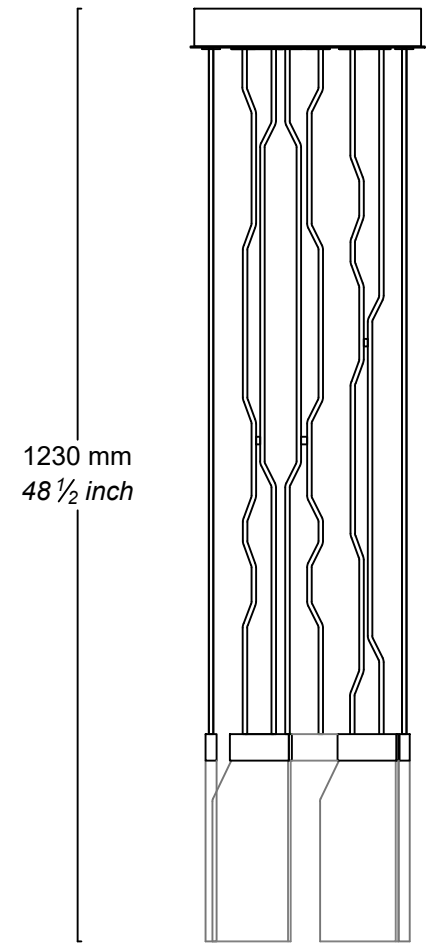
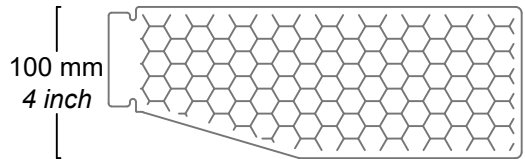
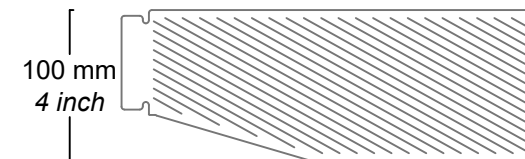
ATHENA 40	ATHENA 30
 <p>Ø 410 mm 16 1/4 inch</p>  <p>1230 mm 48 1/2 inch</p>	 <p>Ø 310 mm 12 1/4 inch</p>  <p>1230 mm 48 1/2 inch</p>
vetro colato - lavorazioni	cast glass texture
H Hive	R Rigadin
<p>nido d'ape 250 mm 9 3/4 inch</p>  <p>100 mm 4 inch</p>	<p>fracco "rigadin" 250 mm 9 3/4 inch</p>  <p>100 mm 4 inch</p>

GRITTI

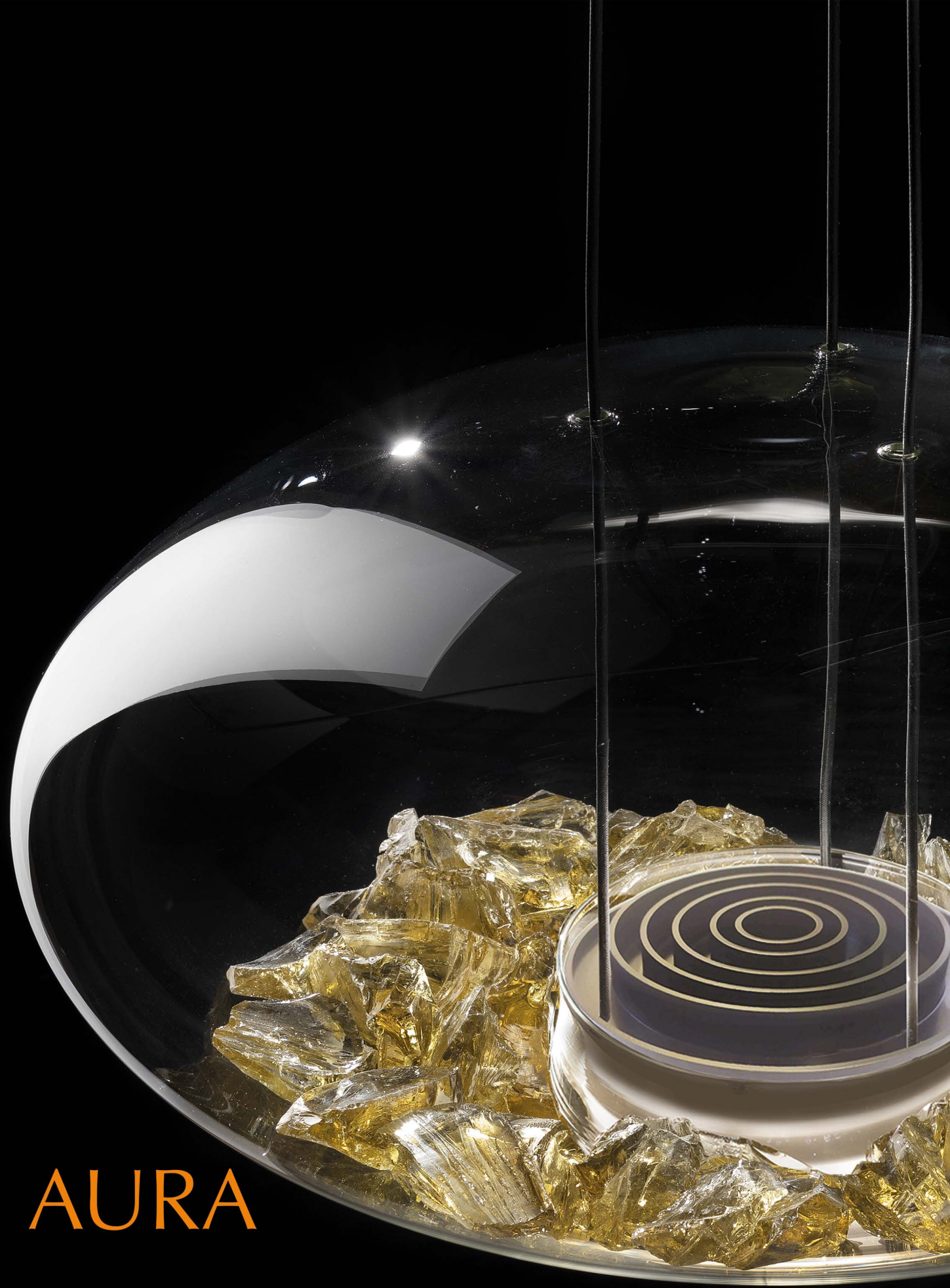

AURA

AURA	Finitura Metallo / Metal Finishes	Finitura Vetro / Glass Finishes	€
	B/N/T/BR/OO	CR/DEN/VER/AMB/BL/AMT/ROS	
AURA S 35	•	•	1.260,00
AURA S 50	•	•	1.717,00
AURA T	•	•	935,00
AURA R	•	•	236,00

DESCRIZIONE  
 Apparecchi di illuminazione con montatura in metallo laccato. Diffusore in vetro trasparente.  
 Cristalli decorativi realizzati in pasta di vetro colorato. Sospensioni con led di potenza.  
 Apparecchio da comodino dimmerabile con bianco dinamico e batteria ricaricabile.

*Luminaires with frame in lacquered metal. Diffuser in clear glass. Decorative crystals made of colored glass paste. Suspensions with LED power. Dimmable table lamp with dynamic white and rechargeable battery.*

Nome articolo _ Item name	Aura S 50	Aura S 35	Aura T	Aura R
tipologia - type	sospensione - suspension	sospensione - suspension	tavolo	comodino ricaricabile
alimentazione - supply	220-240V 50/60Hz	220-240V 50/60Hz	220-240V 50/60Hz	220-240V 50/60Hz
potenza - power	15 W	15 W	6 W	1 W
Kelvin	3000	3000	3000	3000
lumen	2000	2000	800	35
CRI	90	90	90	90

finiture montatura - frames finish

OO Oro Opaco Gold matt	T Titanio Titanium	NO Nero Opaco Black matt	B Bianco Withe	BR Bronzo Bronze
------------------------	--------------------	--------------------------	----------------	------------------

colori del vetro cotisso - "cotisso" glass colors

AMB ambra amber	R rosso red	CR cristallo clear	V verde green	B bianco white	DEN denim denim	AMT ametista amet
-----------------	-------------	--------------------	---------------	----------------	-----------------	-------------------

CURVE FOTOMETRICHE SU RICHIESTA      PHOTOMETRIC CURVE ON DEMAND

SEZIONE DESCRITTIVA      DESCRIPTIVE SECTION

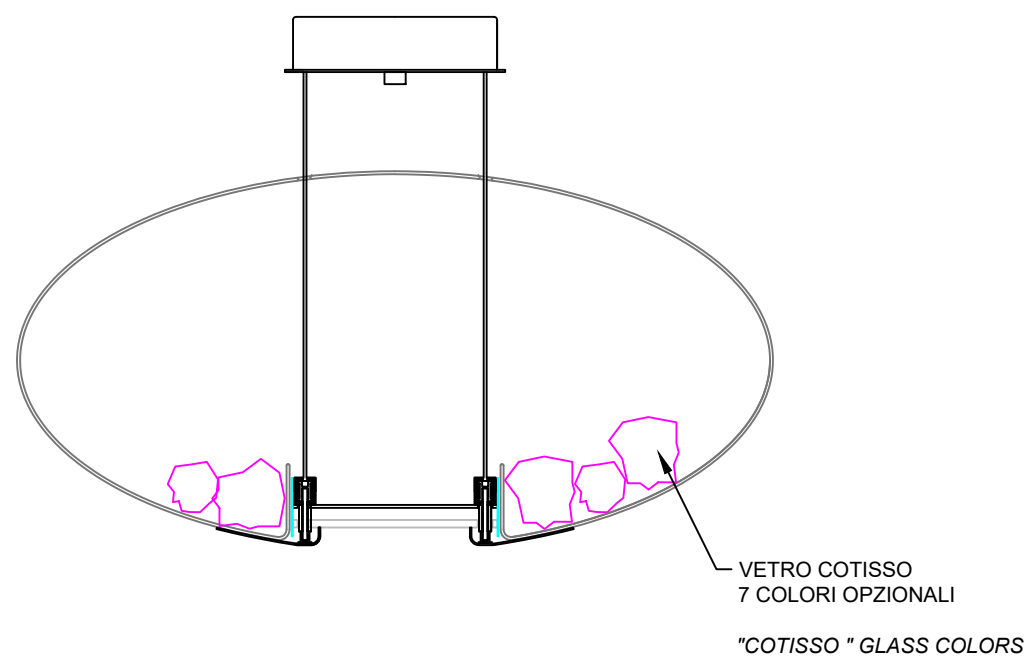

AURA S 35	AURA S 50
AURA T	AURA R - ricaricabile rechargeable





GRITTI

CALIPSO	Finitura Metallo / Metal Finishes		Opzione Modelli / Type choice		Opzioni Colori Particolare in Vetro / Glass Color Detail	€
	B/N	T/BR/OO	Type A	Type B	AMB/ROS/NER/VER/BL/DEN/AMT	
CALIPSO S35	•		•	•	•	2704,00
CALIPSO S35 LUX		•	•	•	•	2992,00
CALIPSO S50	•		•	•	•	3837,00
CALIPSO S50 LUX		•	•	•	•	4054,00
CALIPSO S100	•		•	•	•	4887,00
CALIPSO S100 LUX		•	•	•	•	5104,00
CALIPSO P1	•				•	1519,00
CALIPSO P1 LUX		•			•	1602,00
CALIPSO P2	•				•	1696,00
CALIPSO P2 LUX		•			•	875,00

CALYPSO

GRITTI

Collezione Calypso

DESIGNER

Marc Sadler

Apparecchi di illuminazione con montatura in metallo laccato. Pendenti in cristallo rigadin ritorto a mano. Ogni apparecchio è personalizzabile con un vetro colorato. I pannelli radianti sono realizzati in metacrilato mappato con emissione diffusa e strip a led di potenza. Il driver è incluso.

*Luminaires with frame in lacquered metal. "Rigadin" clear glass handmade pendants. Each piece is customizable with a colored glass. The radiant panels are made in methacrylate mapped with diffuse emission and power LED strips. The driver is included.*

Nome articolo _ Item name	Calypso S 100	Calypso S 50	Calypso S 35	Calypso P1 -P2
tipologia - type	sospensione - suspension	sospensione - suspension	sospensione - suspension	parete - wall
alimentazione - supply	220-240V 50/60Hz	220-240V 50/60Hz	220-240V 50/60Hz	220-240V 50/60Hz
potenza - power	75W	60W	40W	16W
Kelvin	3000	3000	3000	3000
lumen	9000	7200	4800	1920
CRI	90	90	90	90

## FINITURE MONTATURA-FRAMES FINISH

OO Oro Opaco Gold matt	T Titanio Titanium	NO Nero Opaco Black matt	B Bianco White	BR Bronzo Bronze
---------------------------	-----------------------	-----------------------------	-------------------	---------------------

## FINITURA VETRI - GLASS FINISH

cristallo rigadin ritorto





## PARTICOLARE IN VETRO - COLORI DISPONIBILI

## DECORATIVE GLASS - COLORS

AMB ambra amber	R rosso red	N nero black	V verde green	B bianco white	DEN denim denim	AMT ametista amet
--------------------	----------------	-----------------	------------------	-------------------	--------------------	----------------------

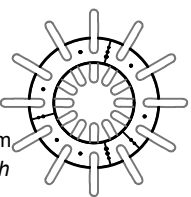
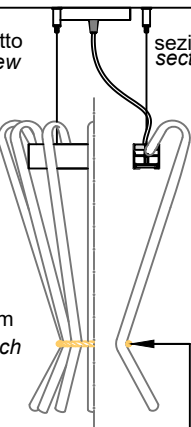
CURVE FOTOMETRICHE SU RICHIESTA

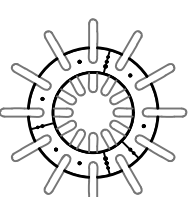
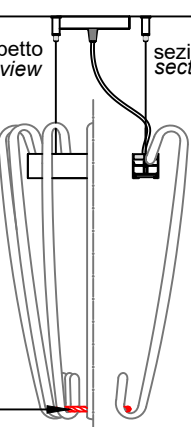
PHOTOMETRIC CURVE ON DEMAND

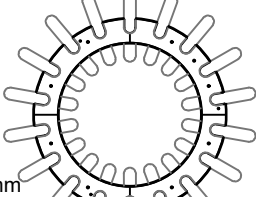
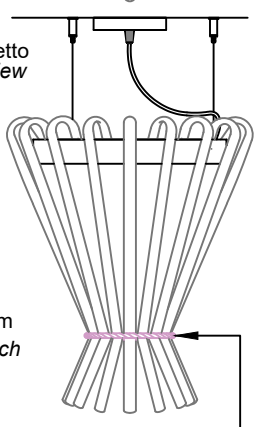
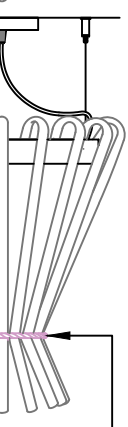
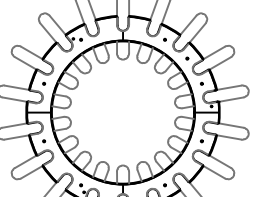
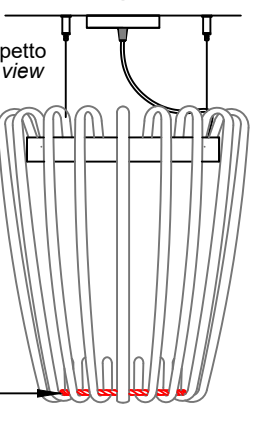
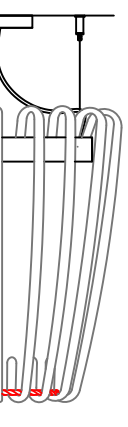
Calypso S 35		Calypso S 50	
MODEL A	MODEL B	MODEL A	MODEL B
<p>pianta plan view</p>  <p>Ø350 mm 13 3/4 inch</p> <p>prospetto side view</p>  <p>600 mm 23 3/4 inch</p> <p>sezione section</p> 	<p>pianta plan view</p>  <p>Ø350 mm 13 3/4 inch</p> <p>prospetto side view</p>  <p>600 mm 23 3/4 inch</p> <p>sezione section</p> 	<p>pianta plan view</p>  <p>Ø500 mm 19 3/4 inch</p> <p>prospetto side view</p>  <p>600 mm 23 3/4 inch</p> <p>sezione section</p> 	<p>pianta plan view</p>  <p>Ø500 mm 19 3/4 inch</p> <p>prospetto side view</p>  <p>600 mm 23 3/4 inch</p> <p>sezione section</p> 
PARTICOLARE IN VETRO disponibile in 7 colori DECORATIVE GLASS available in 7 colors			

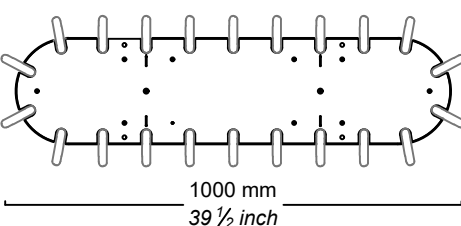
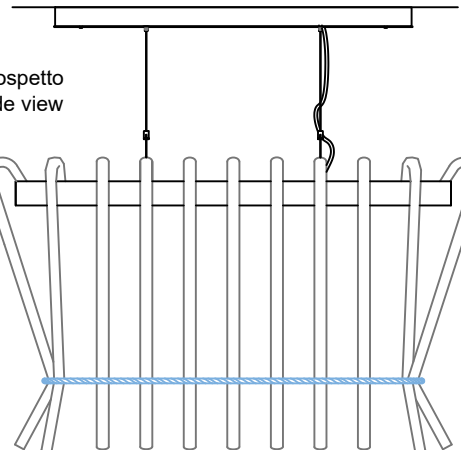
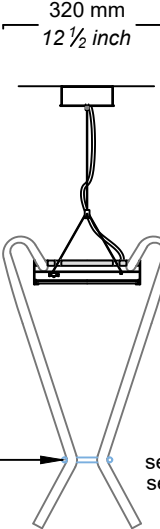
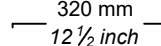
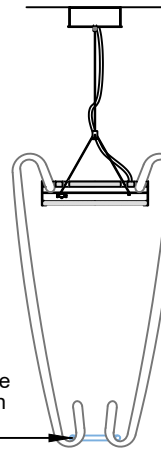
Calypso S 100	
MODEL A	MODEL B
<p>pianta plan view</p>  <p>1000 mm 39 1/2 inch</p> <p>320 mm 12 1/2 inch</p> <p>prospetto side view</p>  <p>max 1800 mm 70 3/4 inch</p> <p>600 mm 23 3/4 inch</p> <p>sezione section</p> 	<p>pianta plan view</p>  <p>320 mm 12 1/2 inch</p> <p>sezione section</p> 
UN PARTICOLARE IN VETRO disponibile in 7 colori DECORATIVE GLASS available in 7 colors	

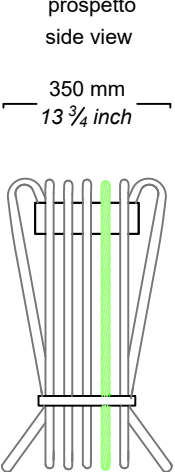
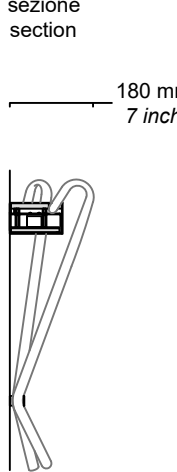
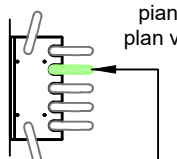
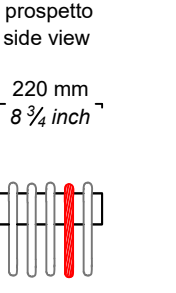
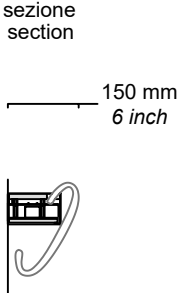
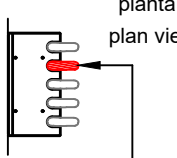
Calypso P2		Calypso P1	
<p>prospetto side view</p>  <p>350 mm 13 3/4 inch</p> <p>600 mm 23 3/4 inch</p> <p>sezione section</p>  <p>180 mm 7 inch</p> <p>pianta plan view</p>  <p>200 mm 8 inch</p>	<p>prospetto side view</p>  <p>220 mm 8 3/4 inch</p> <p>150 mm 6 inch</p> <p>sezione section</p>  <p>pianta plan view</p> 		
UN PARTICOLARE IN VETRO disponibile in 7 colori DECORATIVE GLASS available in 7 colors			

GRITTI



EOS

EOS	Finitura Metallo / Metal Finishes		Finitura Vetro / Glass Finishes		Marmo / Marble	€
	B/N	T/BR/OO	AMB.P/FU.P/GRY.P/VER.P /BL.P/DEN.P/AMT.P	BL	B/N	
EOS S1	•			•		773,00
EOS S1 LUX	•	•	•	•		1.003,00
EOS S2	•			•		1.143,00
EOS S2 LUX	•	•	•	•		1.556,00
EOS S3	•			•		1.143,00
EOS S3 LUX	•	•	•	•		1.556,00
EOS S4	•			•		2.011,00
EOS S4 LUX	•	•	•	•		2.560,00
EOS T	•			•		643,00
EOS T LUX	•	•	•	•		899,00
EOS L1	•			•	•	813,00
EOS L1 LUX	•	•	•	•	•	1.033,00
EOS L2	•			•		995,00
EOS L2 LUX	•	•	•	•		1.296,00
EOS TR1	•			•	•	890,00
EOS TR1 LUX	•	•	•	•	•	1.220,00
EOS TR2	•			•		1.093,00
EOS TR2 LUX	•	•	•	•		1.369,00
EOS P	•			•		431,00
EOS P LUX	•	•	•	•		661,00
EOS PL1	•			•		552,00
EOS PL1 LUX	•	•	•	•		769,00
EOS PL2	•			•		552,00
EOS PL2 LUX	•	•	•	•		769,00
EOS PL3	•			•		552,00
EOS PL3 LUX	•	•	•	•		769,00

P: Vetro soffiato pulegoso / Glass blown covered with bubbles

<b>GRITTI</b> Collezione EOS		DESIGNER <b>Marc Sadler</b>											
DESCRIZIONE Apparecchi di illuminazione con montatura e schermo in metallo laccato. I diffusori sono realizzati a mano in vetro soffiato incamiciato pulegoso, o in bianco latte. <i>Luminaires with frame and screen in lacquered metal. The diffusers are made by hand in "Pulegoso" jacketed blown glass or in milky white color.</i>													
Nome articolo Item name	EOS T	EOS P	EOS PL1	EOS PL2	EOS PL3	EOS L2	EOS TR2	EOS L1	EOS TR1	EOS S1	EOS 2	EOS 3	EOS 4
tipologia type	tavolo table	parete wall	plafone ceiling		lampada da terra floor lamp			sospensione suspension					
alimentazione supply	220-240V 50/60Hz												
potenza power	2 x 5W G9									4 x 5W G9	4 x 5W G9	6 x 5W G9	
lumen	1300									2600	2600	3900	
Kelvin	3000												
CRI	>80												

finiture montatura - frames finish													
OO Oro Opaco Gold matt		T Titanium Titanium		NO Nero Opaco Black matt		B Bianco White		BR Bronzo Bronze					
colori vetro pulegoso				"pulegoso" glass color				vetro diffusore					
AMB p ambra amber		F p fumé smoke		GR p grigio gray		V p verde green		B p bianco white		DEN p denim denim		AMT p ametista amet	
B bianco latte milky white													

CURVE FOTOMETRICHE SU RICHIESTA PHOTOMETRIC CURVE ON DEMAND

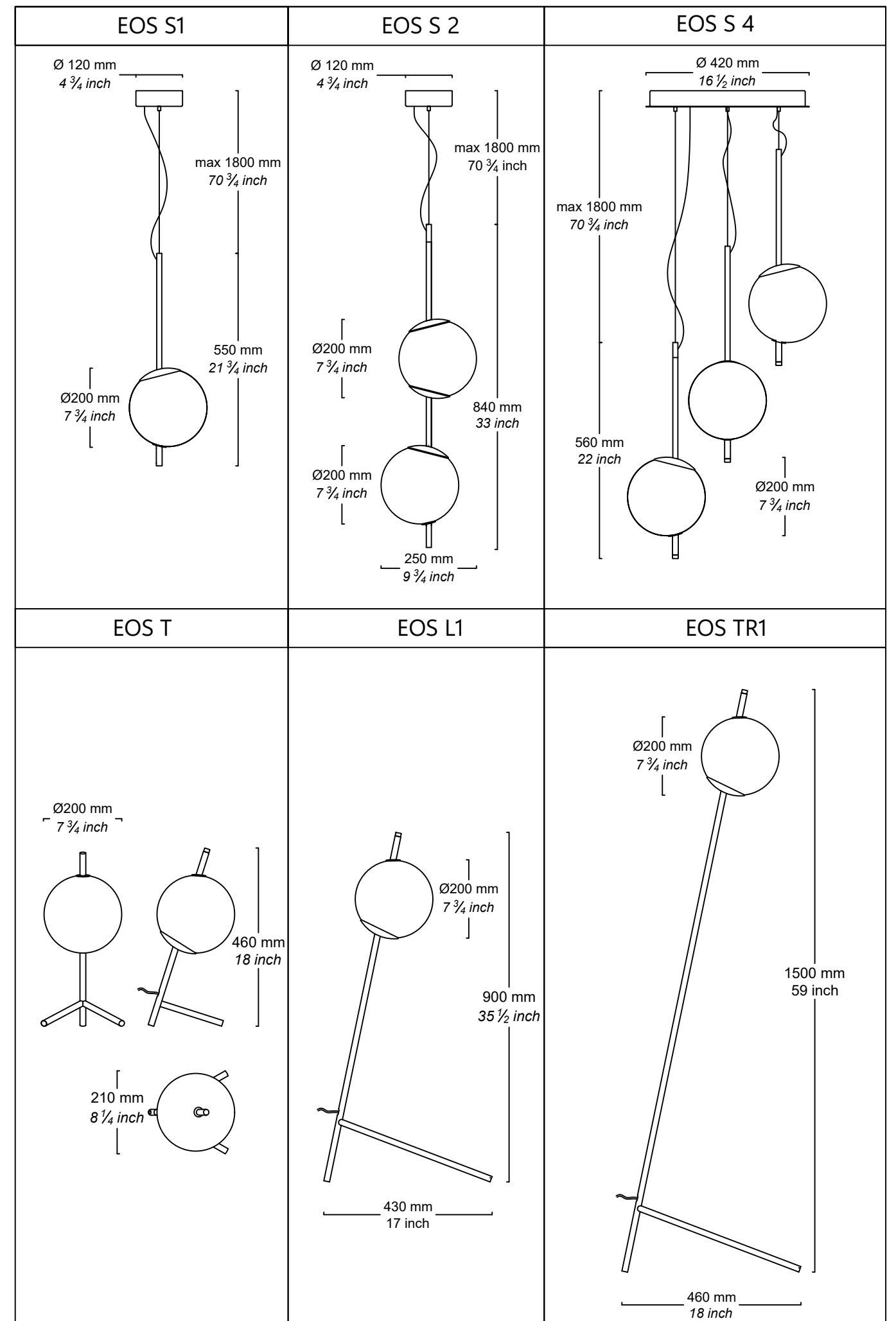
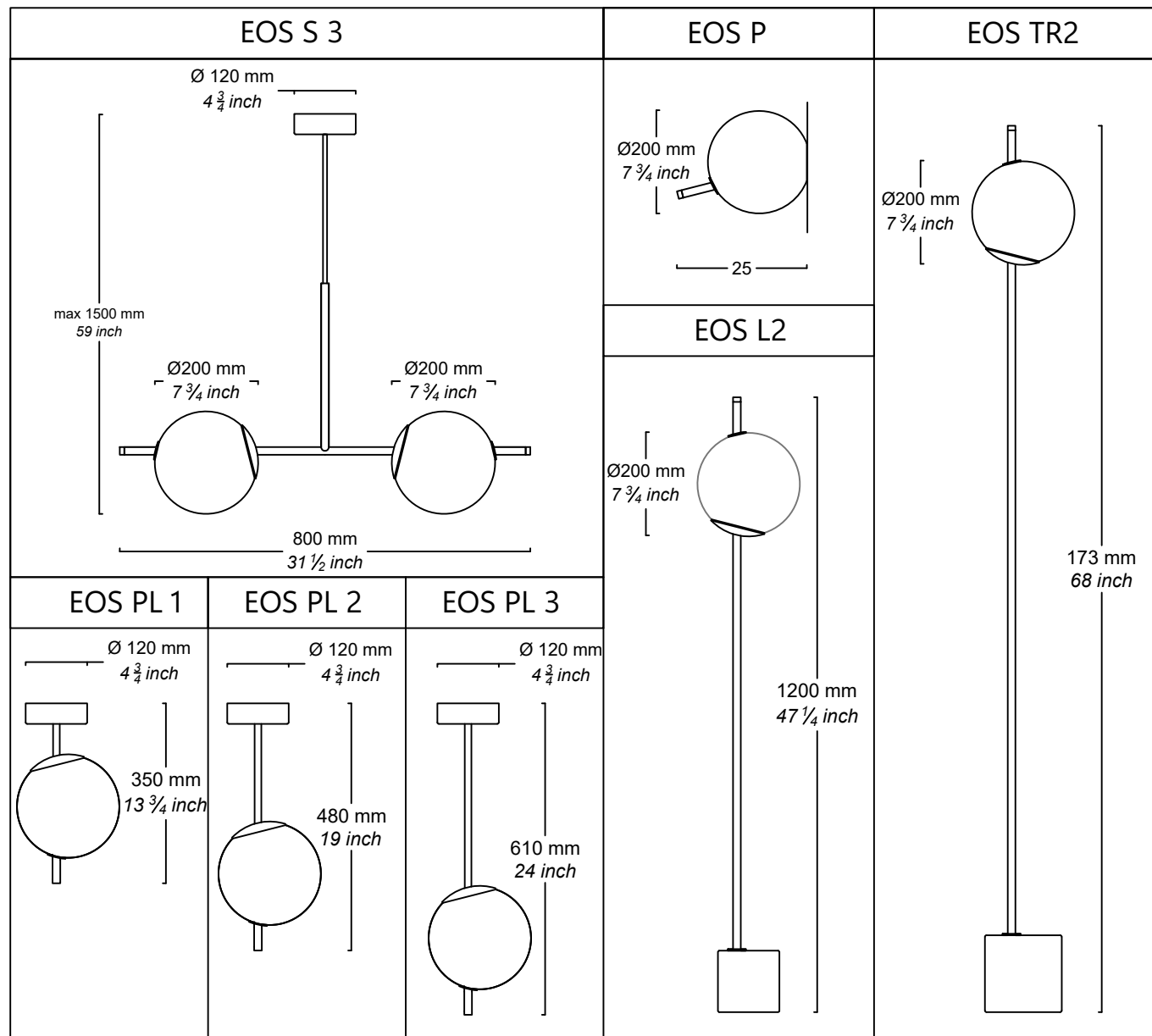



HESTIA

GRITTI

HESTIA	Finitura Metallo / Metal Finishes	Finitura Vetro / Glass Finishes	Opzione colori particolare in vetro / Glass Color Detail	€
	B/N/T/BR/OO	CR	AMB/ROS/NER/VER/BIA/DEN/AMT	
HESTIA S 90	•	•	•	6.124,00
HESTIA S 25	•	•	•	5.607,00
HESTIA S 70	•	•	•	4.167,00
HESTIA P	•	•	•	2.037,00

Apparecchi di illuminazione con montatura e schermo in metallo laccato. Pendenti in cristallo rigadin ritorto a mano.

Ogni apparecchio è personalizzabile con un vetro colorato. I pannelli radianti sono realizzati in metacrilato mappato con emissione diffusa e strip a led di potenza. Il driver è incluso.

*Luminaires with frame and screen in lacquered metal. "Rigadin" clear glass handmade pendants. Each piece is customizable with a colored glass. The radiant panels are made in methacrylate mapped with diffuse emission and power LED strips. The driver is included.*

Nome articolo _ Item name	Hestia S 90	Hestia S 25	Hestia S 70	Hestia P
tipologia - type	sospensione - suspension	sospensione - suspension	sospensione - suspension	parete - wall
alimentazione - supply	220-240V 50/60Hz	220-240V 50/60Hz	220-240V 50/60Hz	220-240V 50/60Hz
potenza - power	46W	46W	42W	16W
Kelvin	3000	3000	3000	3000
lumen	1440 up - 4080 down	1440 up - 4080 down	1440 up - 3600 down	1920
CRI	90	90	90	90

## FINITURE MONTATURA-FRAMES FINISH

OO Oro Opaco Gold matt	T Titanio Titanium	NO Nero Opaco Black matt	B Bianco White	BR Bronzo Bronze
---------------------------	-----------------------	-----------------------------	-------------------	---------------------

## FINITURA VETRI - GLASS FINISH

cristallo rigadin ritorto  
clear glass "rigadin ritorto"

## PARTICOLARE IN VETRO - COLORI DISPONIBILI

## DECORATIVE GLASS - COLORS

AMB ambra amber	R rosso red	N nero black	V verde green	B bianco white	DEN denim denim	AMT ametista amet
--------------------	----------------	-----------------	------------------	-------------------	--------------------	----------------------

CURVE FOTOMETRICHE SU RICHIESTA

PHOTOMETRIC CURVE ON DEMAND

## HESTIA S 70

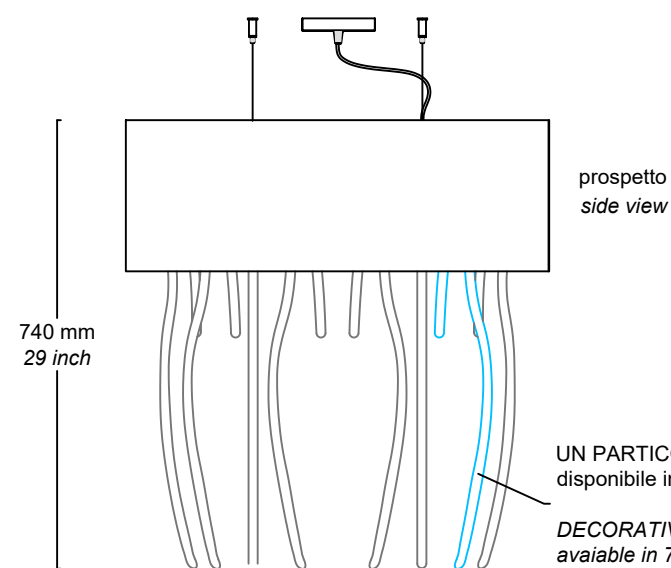
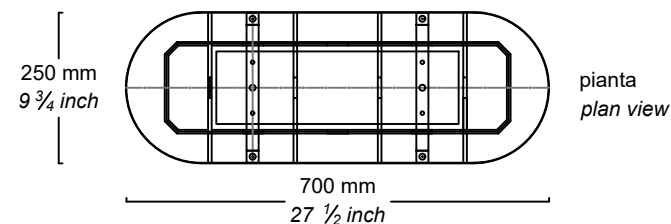

## HESTIA S 90

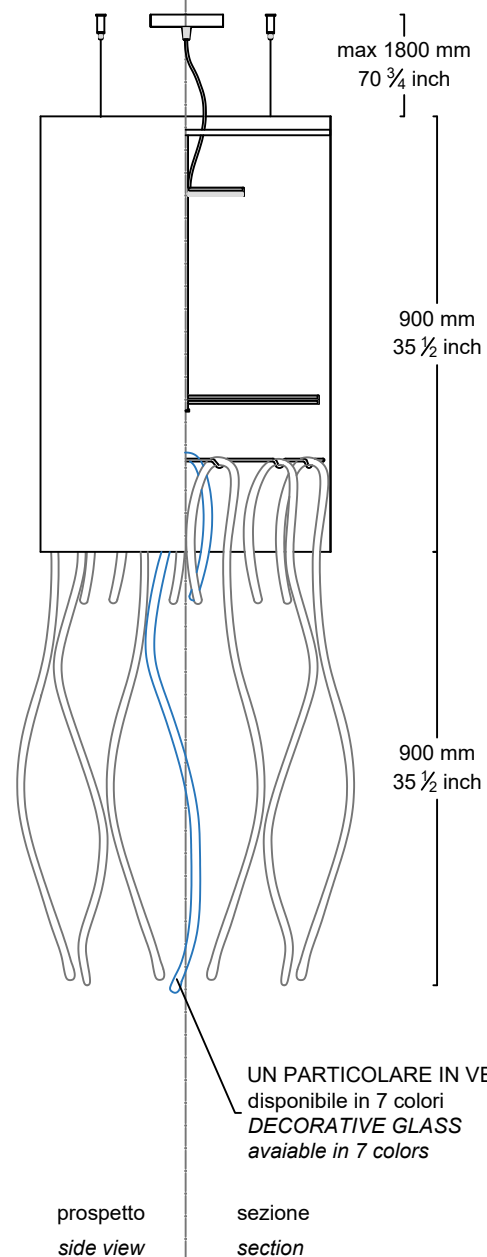
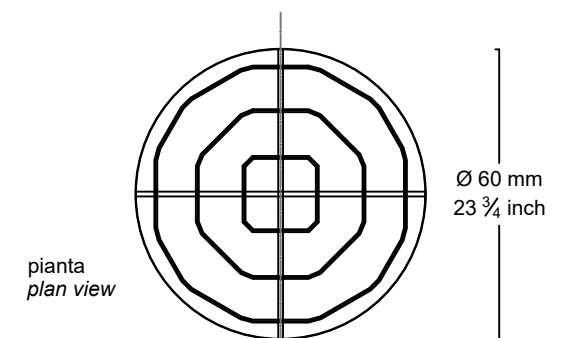

## HESTIA S 25

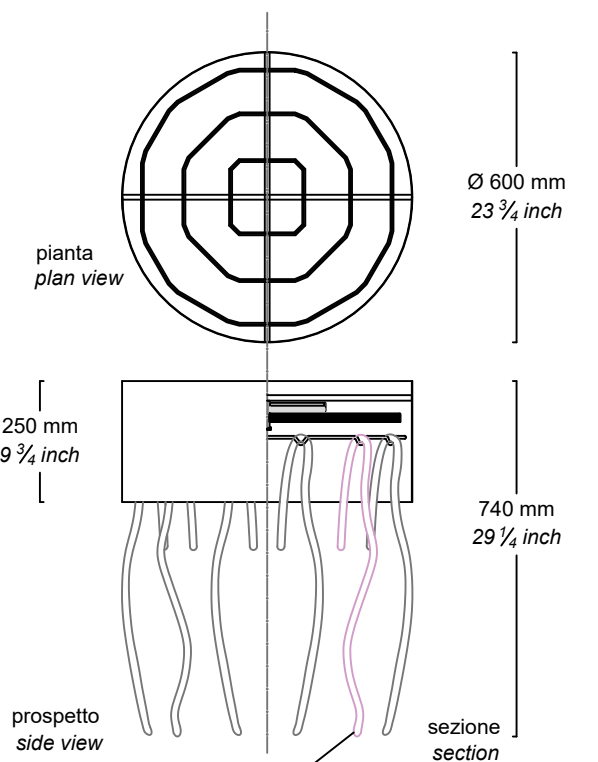

## HESTIA P

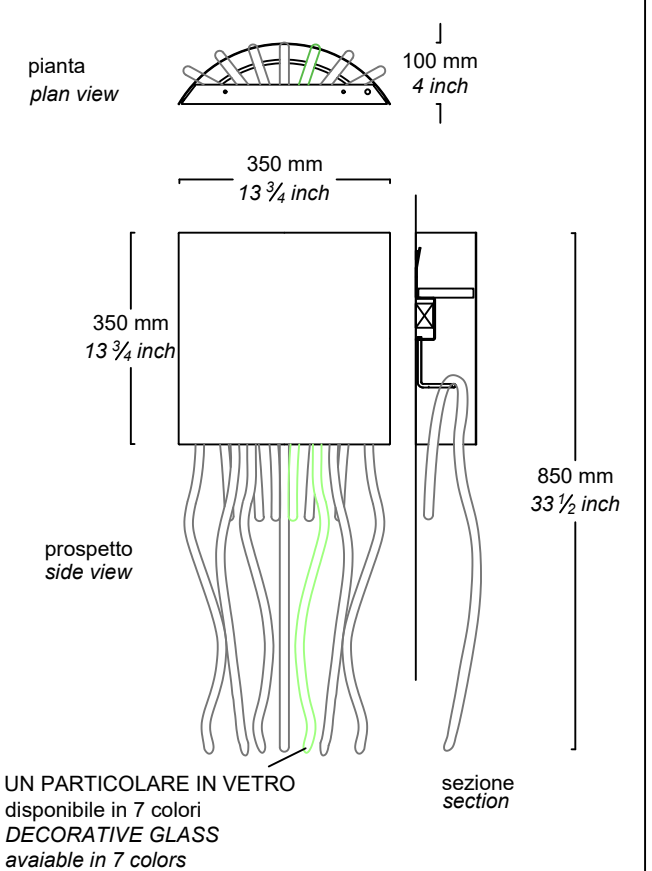

GRITTI

MEDEA	Finitura Metallo / Metal Finishes		Finitura Vetro Stelo/ Stem's Glass Finishes		Finitura Vetro Corolla / Corolla's Glass Finishes		€
	B/BR/OO/T	N	AMB/DEN/VER	ROS	BL	NER	
MEDEA S30	•		•	•	•		502,00
MEDEA S30 BLK		•		•		•	751,00
MEDEA M30	•		•	•	•		537,00
MEDEA M30 BLK		•		•		•	797,00
MEDEA L30	•		•	•	•		585,00
MEDEA L30 BLK		•		•		•	866,00
MEDEA S78	•		•	•	•		554,00
MEDEA S78 BLK		•		•		•	685,00
MEDEA M78	•		•	•	•		588,00
MEDEA M78 BLK		•		•		•	731,00
MEDEA L78	•		•	•	•		637,00
MEDEA L78 BLK		•		•		•	800,00
MEDEA 13.30	•		•	•	•		10.978,00
MEDEA 13.30 BLK		•		•		•	14.292,00
MEDEA 21.30	•		•	•	•		18.128,00
MEDEA 21.30 BLK		•		•		•	23.632,00
MEDEA 37.30	•		•	•	•		28.121,00
MEDEA 37.30 BLK		•		•		•	36.842,00
MEDEA 13.78	•		•	•	•		11.694,00
MEDEA 13.78 BLK		•		•		•	15.188,00
MEDEA 21.78	•		•	•	•		19.285,00
MEDEA 21.78 BLK		•		•		•	25.079,00
MEDEA 37.78	•		•	•	•		30.160,00
MEDEA 37.78 BLK		•		•		•	39.391,00
MEDEA P	•		•	•	•		637,00
MEDEA P BLK		•		•		•	860,00

	Finitura Metallo / Metal	
	B/BR/OO/T/N	
CEILING ROSE C1	•	140,00
CEILING ROSE C2	•	140,00
CEILING ROSE C3	•	367,00
CEILING ROSE C3	•	470,00
CEILING ROSE C5	•	630,00

MEDEA

GRITTI

Collezione MEDEA

DESIGNER

Marc Sadler

Apparecchi di illuminazione con montatura in metallo laccato. Diffusori in vetro borosilicato soffiato e decorato a mano. Sospensioni disponibili anche singolarmente per installazioni custom con driver remoto. Illuminazione led a luce indiretta.

*Luminaires with frame in lacquered metal. Diffusers in blown borosilicate glass decorated by hand. Suspensions are also available individually for custom installations with remote driver. Indirect light led lighting.*

Nome articolo _ Item name	tipologia - type	alimentazione - supply	potenza - power	Kelvin	lumen	CRI
Medea C 1	incasso per 1 sospensione <i>recessed for 1 suspension</i>	220-240V 50/60Hz	5W	-	-	-
Medea C 2	rosone per 1 sospensione <i>canopy for 1 suspension</i>	220-240V 50/60Hz	5W	-	-	-
Medea C 3	rosone per 3 sospensioni <i>canopy for 3 suspensions</i>	220-240V 50/60Hz	15W	-	-	-
Medea C 4	binario per 5 sospensioni <i>linear frame for 5 suspensions</i>	220-240V 50/60Hz	25W	-	-	-
Medea C 5	rosone per 5 sospensioni <i>canopy for 5 suspensions</i>	220-240V 50/60Hz	25W	-	-	-
Medea S-M-L	sospensione componibile <i>suspension for canopy</i>	DC 24V driver non incluso <i>driver not included</i>	5W	3000	500	≥ 90
Medea P	parete <i>wall</i>	220-240V 50/60Hz	5W	3000	500	≥ 90
Medea 37	sospensione <i>suspension</i>	220-240V 50/60Hz	185W	3000	18500	≥ 90
Medea 21	sospensione <i>suspension</i>	220-240V 50/60Hz	105W	3000	10500	≥ 90
Medea 13	sospensione <i>suspension</i>	220-240V 50/60Hz	65W	3000	6500	≥ 90

## FINITURE ROSONE E SPIRALE - CANOPY AND COIN FINISH

OO Oro Opaco Gold matt	T Titanium	NO Nero Opaco Black matt	B Bianco White	BR Bronzo Bronze
---------------------------	------------	-----------------------------	-------------------	---------------------

## FINITURA VETRI - GLASS FINISH

FINITURA VETRI - GLASS FINISH				versione speciale <b>black edition</b>	
STELO - STEM		COROLLA - COROL		STELO - STEM	COROLLA - COROL
AMB ambr amber	R rosso red	DEN denim denim	V verde green	B bianco white	N NERO black

CURVE FOTOMETRICHE SU RICHIESTA

PHOTOMETRIC CURVE ON DEMAND

Medea 37	Medea 21	Medea 13
H78 H30	H78 H30	H78 H30

## MEDEA - Il sistema componibile

## I ROSONI - THE CANOPY

C 1	C 2	C 3	C 4	C 5
Ø 70 mm 2 3/4 inch	Ø 120 mm 4 3/4 inch	740 mm 29 inch	1000 mm 39 1/2 inch	Ø 600 mm 23 1/2 inch
			max 2000 mm 79 inch	

## LE SOSPENSIONI CON VETRI CORTI

## LE SOSPENSIONI CON VETRI LUNGI

L30	M30	S30	L78	M78	S78
300 mm 11 3/4 inch	300 mm 11 3/4 inch	300 mm 11 3/4 inch	780 mm 30 3/4 inch	780 mm 30 3/4 inch	780 mm 30 3/4 inch
160 mm 6 1/4 inch	130 mm 5 1/4 inch	110 mm 4 1/2 inch	160 mm 6 1/4 inch	130 mm 5 1/4 inch	110 mm 4 1/2 inch

## descrizione del diffusore

## description of shade

descrizione del diffusore	description of shade
STELO vetro rigadin disponibile in 4 colori STEM "rigadin" glass available in 4 colors	versione speciale <b>black edition</b>
SPIRALE disponibile in 5 colori COIN available in 5 colors	STELO vetro rigadin rosso STEM "rigadin" red glass
COROLLA COROL	SPIRALE nera black COIN
INTERNO BIANCO INTERNAL WHITE	COROLLA nera black COROL
	interno bianco internal white

## Medea P

	pianta plan view
	prospetto side view
220 mm 8 3/4 inch	



CRITI  
Venezia Italy